

SECTION B-B

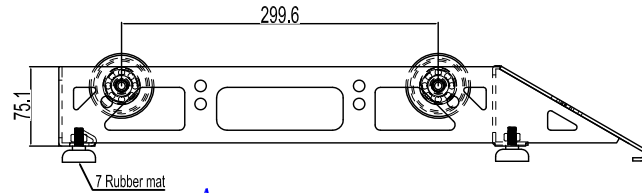

A →

SECTION A-A

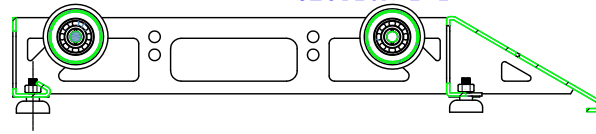
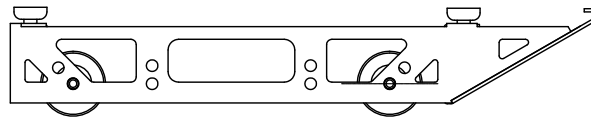
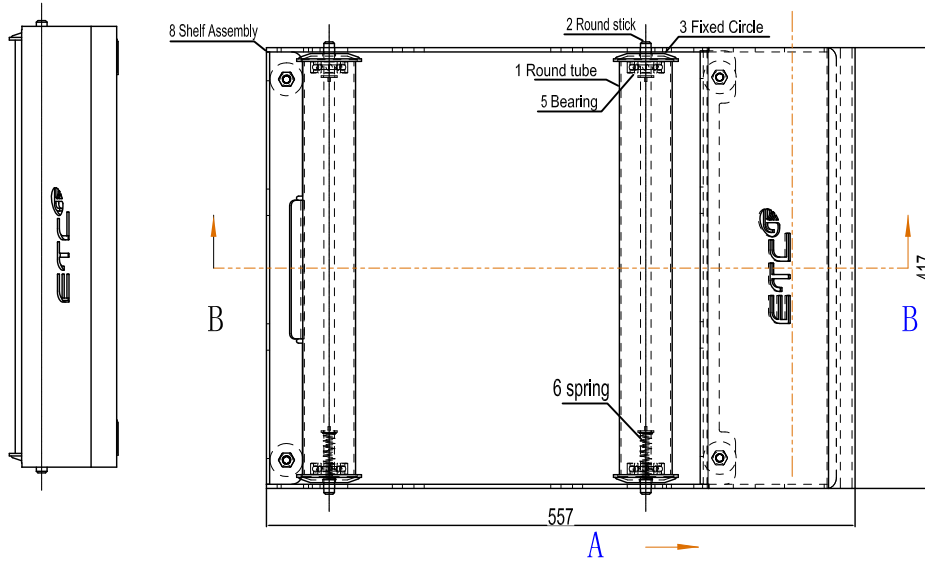
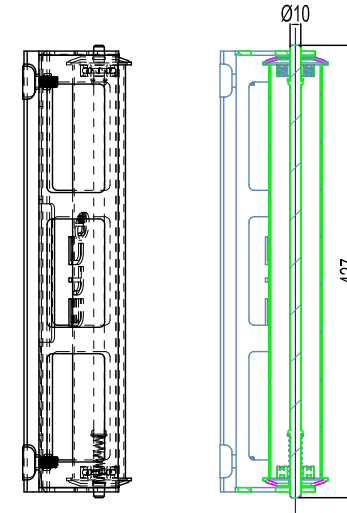

A →



Euro TechnoCom

DESCRIPTION:

MTA4063A1

GENERAL TOLERANCE

CUSTOMER:

DATE: 2019-09-26

±1.0 X° ±2.0°

CUS NO: MTA4063A1

DRAWING: ZHY

±0.2 .X° ±1.0°

PART NO:

CHECKED: Ford

±0.01 .XX° ±0.5°

SY NO: SY-HDXJE00012

APPROVED: Dong

THIRD ANGLE PROJECT



SCALE

NONE

SHEET

1/1

UNIT

MM

REV

A/0

ECN NO

Surface treatment	Zinc plating plate	1	PCS
DESCRIPTION	SPECIFICATION	Q'TY	UNIT

Euro TechnoCom		DESCRIPTION:		MTA4063A1	
GENERAL TOLERANCE		CUSTOMER:		DATE: 2019-09-26	
±1.0	X°	±2.0°	CUS NO: MTA4063A1	DRAWING: ZHY	
±0.2	.X°	±1.0°	PART NO:	CHECKED: Ford	
±0.01	.XX°	±0.5°	SY NO: SY-HDXJE00012	APPROVED: Dong	
THIRD ANGLE PROJECT		SCALE	SHEET	UNIT	REV
		NONE	1/1	MM	A/0
		ECN NO			

Specifications
(Positive and Opposite)

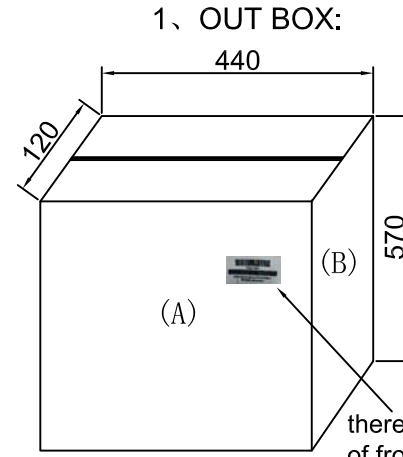
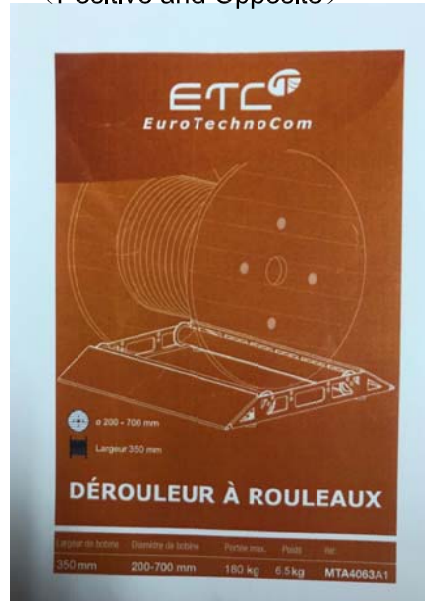

there is a barcode on top right corner of front mark outside the carton

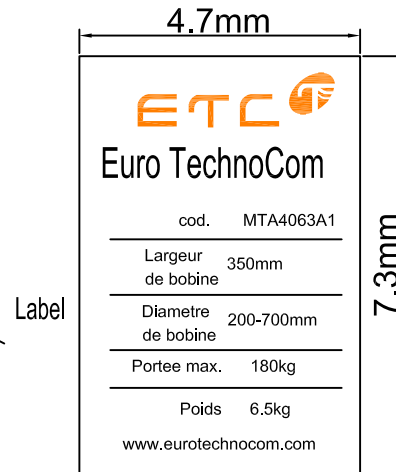

(A)
FRONT MARK



(A)
Label

P/O No.:
Item No.: MTA4063A1
Dérouleur à rouleaux
ETC 200kg en acier
Q'TY. : 1 PCS
N.W. : 6.5 KGS
G.W. : 7.3 KGS
M: 44*12*57 CM

Label

1 pcs in 1 carton , 28 pcs 1 pallet,

②	Pallet size	L:1200 x W:900 x H:1000 mm	1	PCS
①	Out box size	L:440 x W:120x H:570 mm	1	PCS
NO	DESCRIPTION	SPECIFICATION	Q'TY	UNIT

		Euro TechnoCom				
DESCRIPTION:		Package (MTA4063A1)				
GENERAL TOLERANCE		CUSTOMER:			DATE: 2019-09-26	
±1.0	X°	±2.0°	CUS NO: MTA4063A1			DRAWING: ZHY
±0.2	.X°	±1.0°	PART NO:			CHECKED: Ford
±0.01	.XX°	±0.5°	SY NO: SY-HDXJE00012			APPROVED: Dong
THIRD ANGLE PROJECT		SCALE	SHEET	UNIT	REV	ECN NO
		NONE	1/1	MM	A/0	